

**TECHNICAL
MANUAL**

Smoke exhaust axial fan

mcr Monsun C

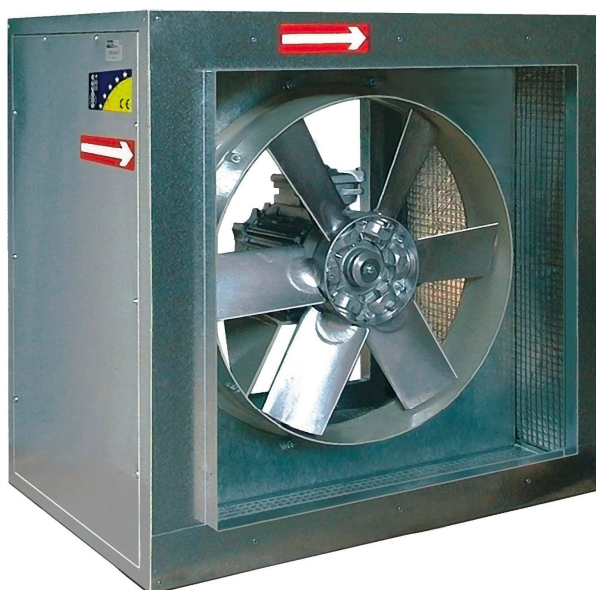

Version: Monsun C 11.08.15.1

CONTENTS:

1. FOREWORD	3
2. MANUFACTURER'S DISCLAIMER	3
3. SUBJECT	4
4. INTENDED USE	4
4.1. APPLICATION	4
4.2. FIRE RESISTANCE	5
4.3. VERSIONS	5
5. DESIGN AND OPERATING PRINCIPLE	5
5.1. DESIGN	5
5.2. FUNCTION	5
5.3. DIMENSIONS	5
5.4. ACCESORIES	6
6. IDENTIFICATION MARKING	6
7. INSTALLATION	7
7.1. INSPECTION BEFORE THE ASSEMBLY	7
7.2. LOCATION AND ASSEMBLY	8
7.3. ELECTRICAL CONNECTIONS	9
7.4. COMMISSIONING	9
8. TRANSPORT & STORAGE CONDITIONS	9
9. SAFETY MANUAL	10
10. MAINTENANCE & SERVICING	10
11. WARRANTY TERMS & CONDITIONS	11
FAN MEASUREMENT REPORT	13

CAUTION

All previous issues of this Technical Manual expire on the date of issue hereof. This Technical Manual does not apply to any fans manufactured prior to this Manual's date of issue.

1. FOREWORD

This Technical Manual is addressed to users/operators of type mcr Monsun C smoke exhaust axial fans. This document is intended to provide guidelines on the application, design, commissioning and operation of the product.



Read this Technical Manual thoroughly before installing this equipment at its operating site and commissioning.



If the equipment is found malfunctioning or defective, contact the manufacturer or their Authorised Representative.



Due to the continuous product improvement policy, we reserve the right to change the product design in order to improve its performance and safety.

The design of the fans complies with the essential requirements of PN-EN 12101-3:2004 for smoke exhaust fans. The design also meets the state of the art in technology, while assuring health and safety protection.

2. MANUFACTURER'S DISCLAIMER

- The manufacturer shall not be liable for any consequences of non-intended use or misuse of the equipment.
- DO NOT install any components that are not included in the equipment composition or accessories.
- Unauthorised modifications or alteration of this equipment is strictly prohibited.
- Protect the equipment enclosure (casing) from mechanical damage.
- Before attempting to install this equipment, verify the load bearing capacity of the structural members to which the equipment is to be fastened. Unreliable fastening may result in damage or failure of the equipment and/or be hazardous to all nearby personnel.
- This fan is not intended for forcing air with viscous pollutants that may settle on the equipment, and especially on its rotor.
- This fan is not intended for forcing air with corrosive pollutants that may be detrimental to the equipment.
- The maximum actual rotor RPM must never exceed the nominal (rated) RPM speed in operation.
- The manufacturer shall not be liable for any injuries, trauma or other bodily harm caused by misuse of this equipment.

3. SUBJECT

The subject of this Technical Manual is:

- mcr Monsun C F400 smoke exhaust axial fans
- mcr Monsun C F400 smoke exhaust axial fans, ATEX certified (ATEX/CAT3)
- mcr Monsun C F300 smoke exhaust axial fans
- mcr Monsun C F200 smoke exhaust axial fans

4. INTENDED USE

4.1. Application

The type mcr Monsun C smoke exhaust axial fan are ducted fans intended to remove smoke and heat generated in indoor rooms on fire. The equipment facilitates evacuation of persons from the area on fire, protect the building structure and its furnishing from high temperature, facilitate fire fighting, and inhibit spreading of fire to adjacent fire zones. The smoke exhaust fans are designed with box casings with extra sound insulation. The form versions available are:

- single-functional with single-speed motors;
- two-functional, i.e. for general and fire ventilation and with two-speed motors.

The fans can be installed indoors or outdoors: on suitable consoles with the motor in the vertical orientation, or on the bottom feet with the motor in the horizontal orientation.

The fan overall compression ratio makes them compatible with ventilation systems characterised by relatively high flow resistance.



The operating temperature range for ventilators in general fan systems is - 20°C to + 40°C.

The fan may force dry air only and with a maximum particulate content of 0.3 g/m³.



This fan is not intended for forcing air with viscous pollutants that may settle on the equipment, and especially on its rotor.



This fan is not intended for forcing air with corrosive pollutants that may be detrimental to the equipment.



The maximum actual rotor RPM must never exceed the nominal (rated) RPM speed in operation.



Following operation in actual fire conditions, the fan will not be fit for further use.

4.2. Fire resistance

- Class F400 – fire resistance at 400°C for 120 minutes
- Class F300 – fire resistance at 300°C for 60 minutes
- Class F200 – fire resistance at 200°C for 120 minutes

4.3. Form versions

- Single-speed single-functional fan
- Two-speed two-functional fans

5. DESIGN AND OPERATING PRINCIPLE

5.1. Design

The mcr Monsun C smoke exhaust axial fan comprises an electrical motor with a suitable insulation class, an axial rotor, a blade assembly and a rectangular outer casing assembly with thermal and sound insulation. Inside of the enclosure the fan motor is located and supported by the motor frame. The motor is coupled directly with an aluminium rotor on bearings, and on the rotor the profiled blades are installed. The angle and number of blades depend on the required compression and capacity of the fan. The motor bearings are high temperature resistant and maintenance free. The medium, which is fire gases and air with smoke, flows through the casing, the motor and the rotor blades. The electrical box is installed on the motor. The suction and pressure ends of the fan features connection stubs.

5.2. Function

The single-functional fans do not run in standby. When supply voltage is present on the electrical box terminals, the fan is started and running.

The two-functional fans run at low speed (RPM) to handle general ventilation under normal conditions. When the fan receives an alarm signal, it automatically starts running with the second speed, which is higher than the first one.

5.3. Dimensions

The basic dimensions are given below with technical data and parameters.

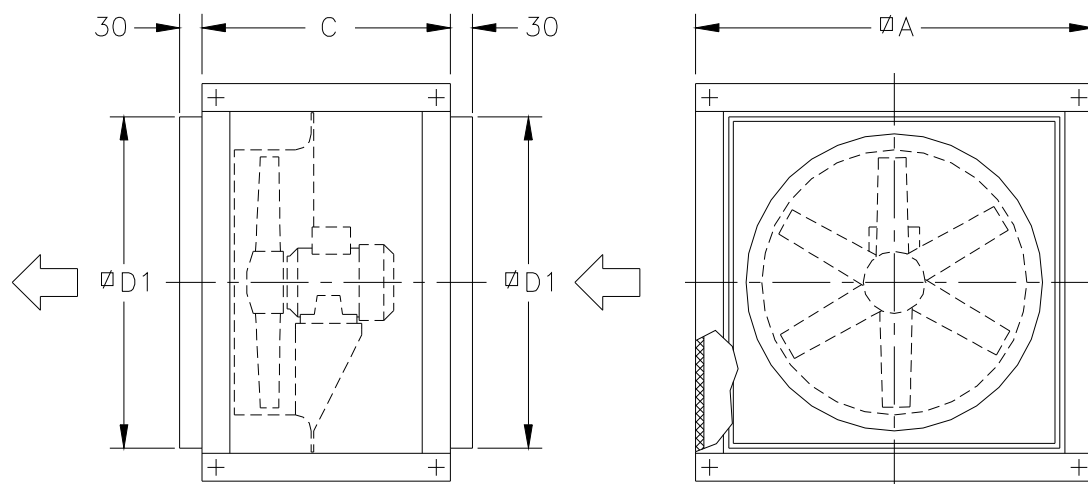

Description	□A	C	□D1
MCR MONSUN C-40/45/50	700	550	565
MCR MONSUN C-56/63	825	550	690
MCR MONSUN C-71/80	1000	650	850
MCR MONSUN C-90/100	1200	750	1050

5.4. Fittings

➤ Type KD flexible joint

The special fiberglass silicate textile ensure durability at 400°C for 120 min.

Type KD flexible joint is used to eliminate the vibrations transmitted from the fan to the ventilation system. It acts as a vibration damper. It is also used to compensate for thermal elongation. The fan integrated in a ventilation system should feature the flexible joint on the suction and pressure sides.

Type KD-c flexible joint			
Fan – Type	Type	D [mm]	L [mm]
mcr Monsun R 40	KD-40c	400	300
mcr Monsun R 45	KD-45c	450	300
mcr Monsun R 50	KD-50c	500	300
mcr Monsun R 56	KD-56c	560	300
mcr Monsun R 63	KD-63c	630	300
mcr Monsun R 71	KD-71c	710	300
mcr Monsun R 80	KD-80c	800	300
mcr Monsun R 90	KD-90c	900	300
mcr Monsun R 100	KD-100c	1000	300

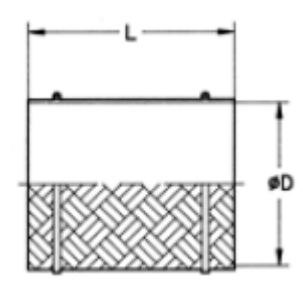

➤ Type PK counterflange

made of galvanized steel sheet. Powder-coated in standard, or galvanized on custom order. This fitting is first used for installation of type KD flexible joints on the fan and to connect the ventilation system to the fan.

Type PK-c counterflange					
Fan – Type	Type	C [mm]	~A [mm]	F [mm]	nxd [mm]
mcr Monsun R 40	PK-40c	400	480	80	8x12
mcr Monsun R 45	PK-45c	450	530	80	8x12
mcr Monsun R 50	PK-50c	500	590	80	12x12
mcr Monsun R 56	PK-56c	560	650	80	12x12
mcr Monsun R 63	PK-63c	630	720	80	12x12
mcr Monsun R 71	PK-71c	710	800	80	16x12
mcr Monsun R 80	PK-80c	800	890	100	16x12
mcr Monsun R 90	PK-90c	900	1000	100	16x15
mcr Monsun R 100	PK-100c	1000	1100	100	16x15

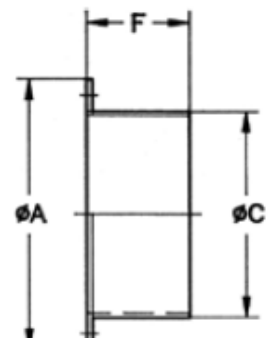

➤ Type SO safety mesh

made of galvanized steel sheet and galvanized wire mesh. Powder-coated in standard, or galvanized on custom order. The fitting protects the fan from ingress of foreign bodies. The product is designed for direct mounting on the fan casing flange with free-flow suction and forcing. Periodically check that the safety mesh is clean and clean it when necessary.

mcr Monsun C smoke exhaust axial fans

Type SO-c safety mesh							
Fan – Type	Type of	D [mm]	A [mm]	~B [mm]	~h [mm]	C [°]	nxd [mm]
mcr Monsun R 40	SO-40c	400	438	470	5	45	8x12
mcr Monsun R 45	SO-45c	450	487	520	5	45	8x12
mcr Monsun R 50	SO-50c	500	541	570	5	30	12x12
mcr Monsun R 56	SO-56c	560	605	640	5	30	12x12
mcr Monsun R 63	SO-63c	630	674	710	5	30	12x12
mcr Monsun R 71	SO-71c	710	751	790	5	22.3	16x12
mcr Monsun R 80	SO-80c	800	837	875	5	22.3	16x12
mcr Monsun R 90	SO-90c	900	934	975	5	22.3	16x15
mcr Monsun R 100	SO-100c	1000	1043	1080	5	22.3	16x15

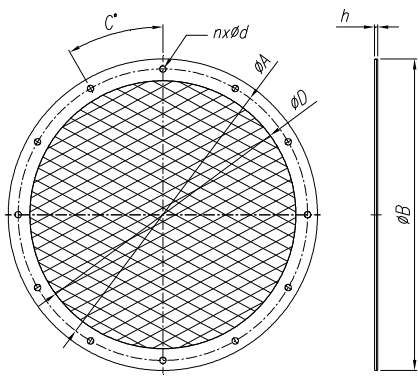

➤ Type AM/BM vibration damper

cap-type vibration damper. The fitting is designed for flexible anchoring of the fan on the substrate, level the equipment and limit the transmission of vibrations to the substrate [by accumulating the vibration energy].

Type AM/BM-c vibration damper										
Fan – Type	Type	A [mm]	B [mm]	C [mm]	E [mm]	F [mm]	M	S [mm]	d [mm]	m [kg]
mcr Monsun R 40	AM-40c	136	80	108	85	135	M12	7	10	0.6
mcr Monsun R 45	AM-45c									
mcr Monsun R 50	AM-50c									
mcr Monsun R 56	AM-56c									
mcr Monsun R 63	AM-63c									
mcr Monsun R 71	AM-71c									
mcr Monsun R 80	AM-80c									
mcr Monsun R 90	AM-90c									
mcr Monsun R 100	AM-100c									

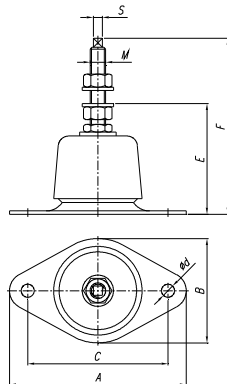

6. IDENTIFICATION MARKING

MCR MONSUN C 40 - 4T - 1 / F400

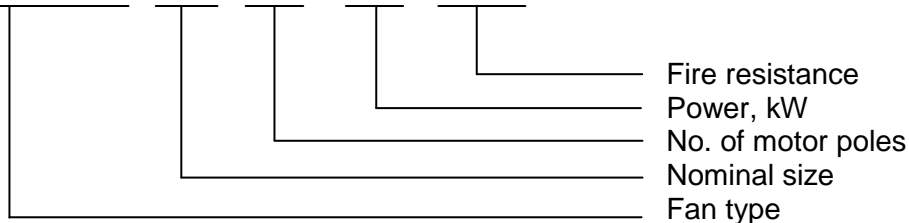

7. DEVICE ASSEMBLY

The mcr Monsun C smoke exhaust axial fan is designed for vertical and horizontal installation. The equipment can be installed indoors or outdoors, on building roofs.

7.1. PRE-ASSEMBLY INSPECTION

Each smoke exhaust fan is factory inspected by the manufacturer prior to packing and shipping. Upon unpacking the delivered smoke exhaust fan, visually examine it for any damage in transport or casing deformation. The motor shaft and the blades should rotate with the rotor without evident resistance.

7.2. LOCATION AND ASSEMBLY

The mcr Monsun C smoke exhaust fan can be installed horizontally or vertically. Prior to installation, verify the load bearing capacity of the roof, floor, wall or ceiling where the equipment is to be located. If the smoke exhaust fan is to be installed vertically on a roof, prepare and secure an opening in the roof slope at a diameter that fits the equipment. Set a special roof fan base over and aligned with the opening, and suitable for the roof type, the fan weight and the fan diameter. Level out and anchor the roof fan base to the roof slope. Place the smoke exhaust fan on the roof fan base with the insulation gasket between the roof base and the smoke exhaust fan flange on the suction end. Fasten both the equipment to the base with bolts. Secure the fan exhaust with a roof exhaust vent assembly to prevent rain water and snow from entering the building through the ducting.

When installing the smoke exhaust fan horizontally, fasten the bottom feet to the fan casing flange with bolts. Set the finished assembly on previously prepared vibration dampers, which have been previously anchored to the substrate or a framework. The anchor and bolt diameter and length must match the equipment size.

When installing the smoke exhaust ventilator below a ceiling, do this on a suitable support structure. Install the vibration dampers and bottom feet on the support structure, then place the smoke exhaust ventilator there. The anchor and bolt diameter and length must match the equipment size.

Connecting the smoke exhaust fan to the (smoke) ventilation system:

Connect the ventilation (smoke venting) duct to the smoke exhaust fan via the installation flange. Use flexible joints fastened to the smoke exhaust fan to reduce the vibration transmission to the ducting. All parts are designed to fit together. This assembly is installed by sealing the joint interfaces and tightening the parts together with the bolts sized according to the fan size. The ventilation duct must not exert loads on the smoke exhaust fan or other components of the assembly. The ventilation duct must be supported by independent bearing slings.

When installing the smoke exhaust fan, secure the installation site and all involved structures, and prepare passage and access ways for all personnel not involved in the installation. The smoke exhaust ventilation must be assured to enable inspection and servicing. Prevent touching the rotor blade disk from touching by adding a length of the duct or installing a safety guard.

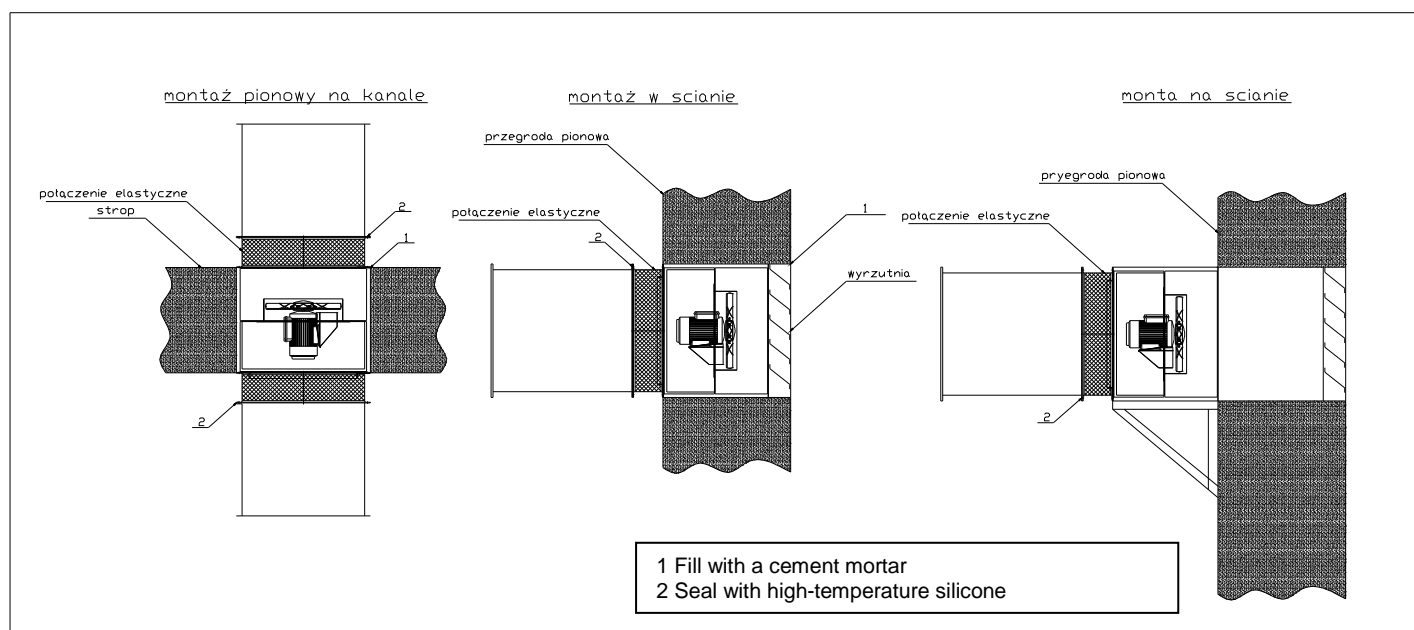

Vertical installation on the duct

Wall installation

On-The-Wall installation

Notes:

- Secure the system against entrainment of foreign bodies and accidental entry of persons, animals, etc.
- Ensure that the fan is aligned with the system components.
- The automatic non-return damper must be levelled for good performance.
- Install a straight duct section with a min. length of 2.5xD on the fan pressure side.
- Seal the system joints with silicone or other high-temperature compound.

7.3. ELECTRICAL CONNECTIONS

Having properly located, placed and fastened the smoke exhaust fan, connect the equipment to the relevant electrical system wiring. Lead the wiring through the gland and into the terminal box on the fan motor; then connect the wiring to the terminals according to the diagram shown in the box. Use fire-resistant wiring.

Each fan motor must be connected to the electrical power system over a safety switch. The safety level must be present according to the nominal current draw of the fan motor. The protective earth shall be made according to relevant electrical engineering standards.

Once the smoke exhaust fan has been commissioned as a part of the system, measure the current draw and verify that it meets the motor rating plate data. The smoke exhaust fan current draw in steady operation must not exceed 1.05 times the current ratings.

The electrical power supply from the control cabinet to the fan power junction box must guarantee uninterrupted operation in the case of a fire. This can be achieved with high temperature resistant wiring or with protective tubing and proper safe routing of the electrical power system. No external service/maintenance switches are to be used, which is to prevent inadvertent shutdown of the smoke exhaust fan (with the sole exception of the ventilator-dedicated service switch with remote indication of current circuit switching). The smoke exhaust fan control cabinets must be powered directly from main switchboards with guaranteed uninterrupted power supply, even if the entire building is cut off from the power grid. If a main fireman's switch is installed to isolate power from the entire building, the smoke exhaust fan power supply must be independent from that solution and assure normal operation in the case of a fire.

Electrical wiring connections must only be made by electricians with valid licenses.

7.4. COMMISSIONING

Before commissioning your installed smoke exhaust fan, do the following:

- Check that the smoke exhaust fan is properly and firmly fastened.
- Check all seals for tightness.
- Check that all electrical wiring is properly and firmly connected.
- Check that the phase connection sequence and PE/neutral wiring is properly connected.
- Check that the smoke exhaust fan and its connected ducting are free of foreign bodies.
- Check that all protective/safety components have been installed.
- If the checks are positive, start the fan and do a functional test.
- When starting the smoke exhaust fan, verify the motor sense of rotation against the direction arrow on the enclosure.

8. TRANSPORT & STORAGE CONDITIONS

During transport and storage, the mcr Monsun C smoke exhaust fans are placed on pallets or in cardboard boxes. Do not topple or throw the packaging during loading and transport. The smoke exhaust fans can be handled and shipped on any means of transport, provided that they are secured against weather and elements. The smoke exhaust fans on transport vehicles must be secured against shifting. Visually inspect each piece of equipment following transport and handling.

Store in sheltered rooms, where:

- there is no exposure to dust particulates, gases, corrosive vapours and other aggressive chemical emissions detrimental to insulation parts and structural components of the fan and/or its motor;
- the maximum relative humidity is 80% at 20°C;
- the ambient temperature does not exceed the range of - 20°C to + 40°C;
- no vibrations are present.

9. SAFETY MANUAL

Read and understand this Technical Manual before commissioning and servicing the product.

The smoke exhaust fan is not hazardous when firmly attached to a ventilation system and the fan support structure.

Make the electrical connections according to the enclosed electrical wiring diagram and the guidelines in Section 7.3. Electrical connections shall be made by personnel with relevant qualifications which have been certified as required by current laws.

Inspect the PE wire connection of the smoke exhaust fan during the operating life.

Disconnect the smoke exhaust fan from electrical power before any inspections or checks.

CAUTION:

1. Do not clean smoke exhaust fans of deposits with pressure or steam washers.
2. Loss of seal at the fan connections or flexible ends may result in hazards due to release of the forced medium and requires immediate replacement of leaking components.

If the equipment is malfunctioning (e.g. excessive noise, vibration and/or erratic operation is found), disconnect the ventilator from electrical power supply, and call the manufacturer's technical service or an inspection and repair contractor authorised by the manufacturer.

10. MAINTENANCE & SERVICING

The equipment from Mercor SA require periodic technical inspection and maintenance at least every 12 months throughout its operating life, i.e. during the warranty and post-warranty period. Inspection and maintenance may only be carried out by the manufacturer or contractors authorised by MERCOR SA to service its products.

The obligation to carry out regular service inspections of fire protection devices results from the Art. 3(3) of the Regulation by the Minister of Internal Affairs and Administration of 7 June 2010 on fire protection of buildings, other civil structures and areas (Journal of Laws, Year 2010, No. 109, item 719).

Do these recommended actions in the inspection intervals:

- Check the electrical connections, especially for all mechanical damage.
- Check the equipment casing, especially for all mechanical damage.
- Check for any obstructions to proper performance of the equipment.

To facilitate the activities under service inspection, servicing and warranty claim response, e.g. visual inspection or repairs, the equipment user/operator shall provide physical access to the equipment by removing thermal insulation, suspended ceiling, and other installations, as required and applicable to warrant unobstructed access, etc.

In the case of roof mounted equipment, provide access to the area (via ladders or elevated platforms).

If the equipment is only operated for smoke exhaust during fire, test run it for ca. 10 minutes every 3 months.

Refer all matters related to technical inspection, maintenance and servicing of this equipment to the Mercor SA Service Department, serwis@mercors.com.pl, tel. +48 58 341 42 45 ext. 170, fax: +48 58 341 39 85, from 8 AM to 4 PM (Mo-Fri).

11. WARRANTY TERMS & CONDITIONS

1. MERCOR SA grants 12 months of warranty for the equipment quality from the date of purchase, unless the sales contract states otherwise.
2. If physical defects of equipment are discovered during the warranty period, MERCOR SA warrants and represents to remove them in 21 days from serving the written warranty claim with the proof of purchase or sales contract, subject to Item 6.
3. MERCOR SA has the right to extend the time of repair if the defect removal is complicated or requires purchase of custom components or spare parts.
4. The warranty liability only covers all defects arising from causes present in the equipment at the date of sale.
5. Defects caused by improper operation or otherwise as listed in Item 6 herein, the buyer / warranty beneficiary will be charged with the costs of their removal.
6. The following components are not covered by the warranty:
 - Any damage or failure of the equipment caused by improper operation, tampering, failure to conduct periodic technical inspection and/or maintenance established in the Technical Manual "SERVICING AND MAINTENANCE".
 - Any damage beyond reasonable control of MERCOR SA, and specifically: caused by force majeure, such as torrential rainfall, flooding, hurricanes, inundation, lightning strike, power grid overvoltage, explosion, hail, collision with aircraft, fire, avalanche, landslide and indirect damage due to those causes. Torrential rainfall is understood as any rainfall with the effectiveness factor of 4 or higher according to the definition of the Polish Institute of Meteorology and Water Management – National Research Institute (IMGW-PIB). If the effectiveness factor value specified in the preceding sentence cannot be reasonably established, the actual condition and extent of damage shall be considered at the site of their origin as the action of torrential rain. Hurricane is understood as any wind with a minimum speed of 17.5 m/s (and damage shall be recognised as caused by hurricanes if the action of such weather phenomenon has been found in the direct vicinity of the damaged property).
 - Damage due to failure to immediately report any defect found.
 - Deterioration in the quality of coatings due to natural weathering/ageing.
 - Defects caused by abrasive or aggressive cleaning agents.
 - Damage caused by aggressive external influence, specifically chemical or biological in nature, or when the origin of which is related to the production processing or activity carried out within the facility protected by the equipment or in its direct vicinity.
 - Wearing parts and consumables (e.g. gaskets/seals), unless they have defects of workmanship and/or material.
 - Damage caused by improper transport, handling, unloading and/or storage of the equipment.
 - Damage caused by installation of the equipment in violation of this Technical Manual and/or good construction practice.
 - The equipment and/or parts thereof with removed or damaged nameplate (rating plate) and/or warranty seals.
7. Submit each warranty claim to MERCOR SA in 7 days from the date of discovery of a warranty eligible defect.
8. Warranty claims may be submitted by calling at: tel. +48 58 341 42 45, by fax: +48 58 341 39 85, by e-mail: reklamacje@mercor.com.pl or by traditional mail: MERCOR SA, ul. Grzegorza z Sanoka 2, 80-408 Gdańsk, Poland.
9. The buyer/warranty beneficiary is required to operate the equipment properly and carry out technical inspection and maintenance according to the Technical Manual "SERVICING AND MAINTENANCE".
10. This warranty shall be made immediately void and null if:
 - The buyer/warranty beneficiary modifies the product design without prior authorisation from MERCOR SA.
 - Periodic technical inspection and/or maintenance are not carried out per schedule and/or are carried out by unauthorised personnel or service providers not authorised to do so by MERCOR SA and/or the equipment has not been properly operated.

mcr Monsun C smoke exhaust axial fans

- Unauthorised personnel attempts any intervention in the product outside of the normal operation and maintenance of this equipment.
11. Any circumstances listed in Item 10 will relieve MERCOR SA from the obligation of surety.
 12. The defects may be removed if the warranty claimant provides free access to facilitate this, especially to the rooms where the equipment has been installed, and provides the necessary inspection access, removal of thermal insulation systems, suspended ceiling, and any other installations which obstruct access to the equipment, etc.

The relevant provisions of the Polish Civil Code shall apply to all matters not regulated in these Warranty Terms & Conditions.

FAN MEASUREMENT REPORT

FAN TYPE	
SERIAL NUMBER	
INSTALLATION SITE	
RATED CURRENT	

Once the fan has been installed at its intended operating site and all electrical connections have been made, immediately measure the current draw in steady-state operation of the equipment.

MEASUREMENT RESULTS [A]

U1	V1	W1	U2	V2	W2

NOTES:

Full name of the measuring technician	Date measured	Signature

Return this Report immediately after completion of measurements to:

MERCOR SA
Fire Ventilation Systems
ul. Grzegorza z Sanoka 2
80-408 Gdańsk

and not later than in 8 weeks from the date of equipment purchase (equivalent to the date of the VAT sales invoice).

THE EQUIPMENT WARRANTY BECOMES ENFORCEABLE UPON RETURN OF THIS MEASUREMENT REPORT